

Contents

Introduction	2
Filter bag construction	3
- Technical Support	4
Filter Bags	
Filter bag selection	5
POMF Microfibre Filter bags	7
PONG Polypropylene Felt Filter Bags	8
PENG Polyester Felt Filter bags	9
NMO Nylon Monofilament Mesh Filter bags	10
SSM Stainless Steel bags	11
CHF High Flow Element	12
Cartridges	
Introduction	
- End Fitting Types	13
CSW String Wound	14
CMB Meltblown	15
CC Activated Carbon	16
CME Nylon 6 Pleated	17
CPL Polypropylene Pl.	18
CME PES Membrane	19
CME PTFE Membrane	20
CPL Stainless Steel	21
CHF High Flow Pleated	22
Pressure Vessels	
How to select a Vessel	23
PVPP Polypropylene	25
PVBS Steel Side Entry	27
PVBT/-BA Steel Top Entry	28
PVHF High Flow Vessel	30
PVBM Multi Bag Vessel	31
PVSE Strainer, Separator	33
PVSC Self Cleaning Filter	34
PVCM Multi Cartridge Filter	36
PVFM Flow Meter	37
Accessories	38
PSSI Simplex Strainer	39
Local Production	40
Contact details	41

Introduction

History

For almost 30 years Sefar Oceania has developed a unique range of high quality liquid filtration products.

Sefar Australia started to manufacture filter bags in the 1970's, using premium quality felt- and Sefar monofilament mesh material.

The strong partnership between Sefar and the leading manufacturers of liquid filtration products allows us to provide our customers with innovative products & solutions. Our goal is to provide our customers assistance in choosing the ideal application solution, offering the highest levels of product quality and output while helping them improve their bottom-line performance.

We are dedicated in our offering of designed industrial liquid solutions that minimize downtime on continuous or batch operating systems. Our products have established new standards for industrial filtration, purification and separation within a changing industry. Innovative Designs Solve Problems:

As a leader in the manufacturing of filter products Sefar has the experience and insight to create products for speciality applications. Our research and development engineers assess the processing requirements of our customers in order to provide accurate and efficient filtration systems, even under unusual conditions and circumstances.

Many of our custom-built solutions include:

Ergonomic 45 degree filter vessels:

Designed to reduce the OH & S issues when changing out filter bags.

Multipurpose vessels:

Vessels to accommodate filter bags and high flow elements capable of increasing flow rates by four times and providing absolute filtration.

Sanitary finish:

Vessels designed and built to meet the requirements of the food and beverage industry.

Duplex Filter Systems:

Two or more vessels fitted together with valving to permit continuous use or when a bag change out is required.

Please contact a member of our sales team for more information and assistance.

Poly Welded Construction and the Multi Seal Collar

Poly Welded Construction

Poly Welded Filter bags hold a distinct advantage over all types of needle-sewn bags.

The welded seams completely eliminate the possibility of unfiltered liquid bypass occurring due to needle holes. The results is a tighter seam, higher bag efficiencies and improved finish product yields.

In addition, the fused edges of our Poly Welded Filter bags provide a fibre-free finish and virtually eliminate unwanted fibre migration. Since the PolyWeld bag is not constructed with thread, the possibility of silicone contamination from this source is also removed.

The picture to the right shows the difference of liquid bypass of a welded seam (left) to a conventional bag with needle-sewn bags.



Multi Seal Collar

The top, together with the Multi Seal collar, creates a hermetic seal within a vessel housing to prevent liquid bypass. The patented Multi Seal Collar fits securely over the lip of the restraining basket, eliminating the sealing concerns of ordinary steel ring bags.

It is available in polypropylene, polyester and nylon materials. To facilitate bag removal, handles are built into the Multi Seal Collar. They provide a more stable grip to help prevent spillage during bag changeover.



Steel Ring Design

Filter bags with steel ring (available in galvanised or stainless steel) are used in older style vessels or for gravity fed applications.

Adapter Heads are available in a variety of pipe size and materials to be used with steel ring bags in open filter system. Adapter heads are ideal for applications where vessels are impractical, see page 38 for further details.

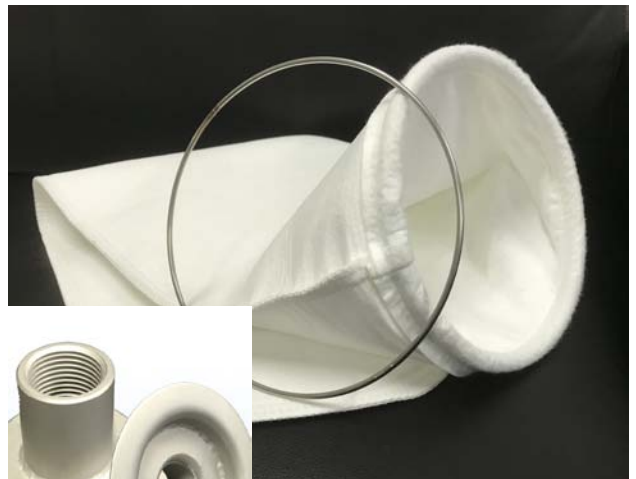

Filter Bag Selection

Questionnaire

Criteria	Question	Reason	Answer	Code
Type of product	What is being filtered? Chemical compatibility	Chemical compatibility with filter media		
Operating temperature	Temperature at the filter?	Temperature compatibility with filter media		Deg.C ^o
Viscosity at temperature	Resistance of fluid to motion?	Selection of filter media type		SG
Particle sizing	What are we removing?	Selection of filter media type		Micron
Cleanliness level required	Micron Rating?	Selection of filter media grade		Micron
Dirt-Loading, Type of dirt	Which filter media type is suitable?	Selection of filter media type		
Flow rate, batch size	Volume processed?	Sizing of filter bags and vessels		l/min
System pressure	Pump capability?	Sizing of filter bags and vessels		bar
Pipe size	System compatibility?	Sizing of filter vessels		inch / mm
Pipe material quality	System compatibility?	Quality of filter vessel material		SS, MS, Poly
Differential pressure	Difference between 2 pressure points in the system	System sizing		bar

Suspended solids conversion Table

PPM	%	g per litre	LBS/1000 Gal
10000	1%	9.586	80
8000	0.8000%	8.388	70
6000	0.6000%	5.991	50
4000	0.4000%	4.194	35
2000	0.2000%	1.797	15
1000	0.1000%	1.078	9
800	0.0800%	0.779	6.5
600	0.0600%	0.659	5.5
400	0.0400%	0.419	3.5
200	0.0200%	0.210	1.75
100	0.0100%	0.102	0.85
80	0.0080%	0.078	0.65
60	0.0060%	0.060	0.5
40	0.0040%	0.042	0.35
20	0.0020%	0.021	0.175
10	0.0010%	0.010	0.08
8	0.0008%	0.008	0.065
6	0.0006%	0.007	0.055
4	0.0004%	0.004	0.035
2	0.0002%	0.002	0.0175
1	0.0001%	-	0

Media Selection by Dirt Holding Capacity

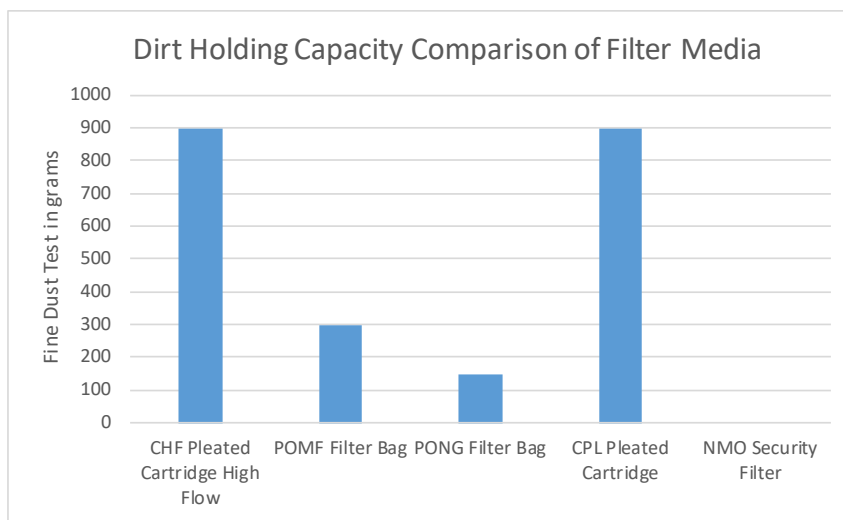

A higher dirt loading capacity indicates longer service life, eg less bag change-outs, longer on line filtration, reduction in overall cost

When to change a filter bag

Pressure drop DP	Comment
< 0.15 bar or 2.1 psi	Recommended clean pressure drop
0.8 - 1.3 bar or 11-19 psi	Recommended change out pressure drop
> 1.8 bar or 26 psi	Maximum change out pressure drop

Use of Flow Meters, see Page 37



Filter Bag Selection

Filtration Efficiency - Comparison Chart

Comparative Filtration Efficiency			Filtration Media Type and Respective Filtration Efficiency Rating				
Micron Rating			CHF	NMO/SSM	POMF	PENG	PONG
Nominal	@95%	@99%	Absolute @99%	Absolute @99%	Absolute @95%	Nominal	Nominal
0.1	0.2	0.5	CHF .5				
0.2	0.3	1	CHF 1				
0.2	0.5	3	CHF 3				
0.3	1	5	CHF 5		POMF 1		
0.4	2	7			POMF 2		
0.5	3	8			POMF 3		
0.8	5	10	CHF 10	NMO 10	POMF 5		
0.9	10	20	CHF 20		POMF 10		
1	15	25		NMO 25			
1	20	40	CHF 40				
1	25	50	CHF 50	NMO/SSM 50	POMF 25	PENG 1	PONG 1
3	35	60				PENG 3	PONG 3
3	40	70	CHF 70				
4	45	80					
5	50	90			POMF 50	PENG 5	PONG 5
10	60	100	CHF 100	NMO/SSM 100		PENG 10	PONG 10
15	70	110					
20	80	115					
25	90	120	CHF 120			PENG 25	PONG 25
50	100	150		NMO/SSM 150	POMF 100	PENG 50	PONG 50
100	140	180				PENG 100	PONG 100
150	180	200		NMO/SSM 200		PENG 150	PONG 150
200	250	400		NMO/SSM 400		PENG 200	
400	450	600		NMO/SSM 600			
600	650	800		NMO/SSM 800			
800	850	1000		NMO/SSM 1000			

Efficiency Comparison Chart

Within this Chart we have provided details of a range of bags/Elements that all fit into standard P2 size vessels. It is important to not over filter as this will result in shorter life. If existing nominal filtration is working and an absolute filter is still required then select the absolute filter by following the chart, eg PENG or PONG 1 micron filter bag equals an absolute 50 micron CHF element at 99% filtration efficiency.

Nominal Rating

On the other hand, Nominal micron ratings are average or general in nature. Their efficiencies can fall anywhere between 50% and 95% with the norm being around 80% efficiency. That is to say, a one micron nominally rated filter bag will remove approximately 80% of "challenge particles" one micron or larger under laboratory conditions. Eg PONG and PENG Bags

Absolute Rating

As the name suggests, absolute conjures up a notion of 100% pure filtration. Absolute rated filter bags are generally between 90% and 95% efficient with cartridges and membranes from 95% to 99.9% so contrary to their name, are not absolute (100%). They are generally gauged by the percentage of contaminate particles they are capable of removing in perfect laboratory conditions. For example, a 1 micron Absolute rated filter bag will remove between 95% and 98% of laboratory "challenge particles" 1 micron or larger. They are not 100% efficient. For this reason we refer to this type of filter bag as "Absolute @95% efficiency" eg POMF filter Bags.

When 99% efficiency is required within a vessel you can now use CHF range of Elements, this combines the efficiencies of a filter cartridges with the benefits of a bag.

Filter Bag Selection

Standard Size of Filter bags

Picture						
Size	1	2	2D	3	4	5
Filter bag area in m2	0.19	0.45	1.0	0.05	0.1	0.19
Content, litre	7.9	17	34	1.5	2.5	7.9
Bag Dia. mm	178	178	178	102	102	152
Bag Length mm	419	813	1,500	229	381	559
To suit Vessel type	PVBS	PVBS, PVBT, PVBA, PVBM, PVPP, PVPPM	PVGF	PVBS, PVBT	PVBS, PVBT	PVPP

Performance of the different filter bag materials

Type	Code	Material	Description	Flow Rates based on No 2 bag		Dirt Holding Capacity grams
				Micron Size	Flow Rate	
Mesh	NMO	Nylon	Absolute rated 10 up to 1200 µm No Fibre migration High Tensile Strength Surface Filtration	10 µm: 25 to 100 µm: 150 to 1000 µm:	380 l/min 475 l/min 565 l/min	0 g
Mesh	SSM	316SS	Absolute rate 50 - 600 µm High Tensile Strength High Temperature resistance	50 to 100 µm: 125 to 1000 µm:	475 l/min 565 l/min	0 g
Felt	PONG PENG	Polypropylene Polyester	Nominal rated 1 up to 200 µm FDA compliant available Glazed outside to inhibit fibre migration	1 & 3 µm: 5 to 200 µm:	300 l/min 450 l/min	150 g 150 g
Micro-Fibre	POMF	Polypropylene	Absolute rated 1 up to 100 µm at 95% FDA compliant available Mesh outside to inhibit fibre migration	1A & 2A : 10A - 100A :	230 l/min 380 l/min	300 g
Pleated Micro-Fibre	CHF HI_FLOW ELEMENTS	Polypropylene	Absolute rated 5 up to 120 µm @99% High dirt loading capacity Combined with high flow rates FDA compliant	0005, 001, 003, 005, 010, 020, 040, 070, 100, 120	700 l/min	900 g

Filter Fabric Qualities and Suitability

Fabric	Cotton	Polyester	Glass	Nylon	Nomex	Polypropylene	316 SS
		PENG		NMO		PONG	SSM
Specific Gravity	1.55	1.38	2.56	1.14	1.14	0.9	0.798
Tensile Strength	44-109	64-124	200-215	58-128	58-128	50-85	290-580
Abrasion and Flex	Fair	Very Good	Poor	Excellent	Very Good	Very Good	Excellent
Weak Acids	Poor	Very Good	Excellent	Fair	Fair	Excellent	Very Good
Strong Acids	Poor	Good	Good	Poor	Poor	Excellent	Very Good
Weak Alkali	Excellent	Good	Fair	Excellent	Excellent	Excellent	Very Good
Strong Alkali	Excellent	Poor	Poor	Excellent	Excellent	Excellent	Very Good
Solvent	Good	Good	Excellent	Good	Good	Fair	Very Good
Temperature Deg.C ^o	90 - 115	135 - 160	260 - 315	135 - 160	205 - 230	90 - 105	450

StreamTex POMF

Polypropylene Microfibre Filter Bags

Features

- Precise particle retention (>95%)
- Long service life of 2-3 times of a standard felt bag
- Less filter bag change-outs
- Lower total cost of filtration

The POMF series of high performance bags are designed for your critical areas of filtration. Contaminant removal efficiency at well over 95% make this one of our leading filters within the StreamTex range.

The media is effective in removing gelatinous contamination due to its unique structure. Filters particles throughout the depth of the media. Wide range of applications with FDA compliant polypropylene media. Non foaming, no surfactant. Safe for all critical applications incl Dairy, Pharmaceutical and high purity water production.



POMF Polypropylene Microfibre Filter Bags

Bag Size	Ring Type	Material	Micron Rating Absolute @95%
P1 P2 P2D	P = Multi Seal Collar S = Steel ring	POMF Microfibre	1A = 1 Micron 3A = 3 Micron 5A = 5 Micron 10A = 10 Micron 25A = 25 Micron 50A = 50 Micron 100A = 100 Micron

Order example:

Size 2 bag 10 Micron absolute rating with standard Multi Seal Collar in POMF material = P2P-POMF-10A

Composed of continuous length microfibrils that vary in diameter throughout the depth of the filter medium. This unique design allows for uniform graded pore size distribution.

This unique multi-layer design produces a gradual reduction in the degree of filtration towards the downstream filtrate side of the filter.

Thus ensuring varying particle size entrapment throughout the layers and stable flow consistency. Made from 100% Pure Polypropylene microfibrils containing no resin, lubricants, bonding adhesives, silicone or anti static chemicals.

StreamTex PONG

Standard Type Polypropylene Felt Filter Bags

Features

- Six standard industrial sizes available
- Robust and reliable construction
- Fully welded design eliminates bypass
- Unique Multi Seal Collar for compression sealing mechanism
- Silicone free needle felt
- Available in 100% Polypropylene
- FDA compliant

For no compromises, 100% by pass free filtration, the PONG Filter bag is one of the most versatile and popular bags on the market.

Unfiltered liquid bypass, seen when using steel ring designs, is eliminated by using our plastic collar which is ultrasonically welded to the bags, allowing for perfect sealing. The welded seam design eliminates bypass caused by stitching holes and guarantees no contaminate to bypass during operation.



PONG Polypropylene Filter bags, Welded Seams

Bag Size	Ring Type	Material	Micron Rating Nominal
P1 P2 P2D P3 P4 P5	P = Multi Seal S = Steel ring	PONG Polypropylene Felt, Glazed Finish	0005, 001, 005 010, 025, 050 075, 100, 150 200

Order example:

Size 1 bag 5 Micron with standard Multi Seal collar in PONG material = P1P-PONG-005

Size 4 bag 100 Micron with Special steel ring P4S-PONG-100

StreamTex PENG

Standard Type Polyester Felt Filter Bags

Features

- Six standard industrial sizes available
- Robust and reliable construction
- Fully welded design eliminates bypass
- Unique Multi Seal collar design for compression sealing mechanism
- Silicone free needle felt
- Available in 100% Polyester
- FDA compliant

For no compromises, 100% by pass free filtration, the PENG Filter bag is one of the most versatile and popular bags on the market.

Unfiltered liquid bypass, seen when using steel ring designs, is eliminated by using our Multi Seal collar which is ultrasonically welded to the bags, allowing for perfect sealing. The welded seam design eliminates bypass caused by stitching holes and guarantees no contaminate to bypass during operation.



PENG Polyester Filter bags, Welded Seams

Bag Size	Ring Type	Material	Micron Rating Nominal
P1 P2 P2D P3 P4 P5	P = Multi Seal S = Steel ring	PENG Polyester Felt	0005, 001, 005 010, 025, 050 075, 100, 150 200

Order example:

Size 1 bag 5 Micron with standard Multi Seal collar in PENG material = P1P-PENG-005

Size 4 bag 100 Micron with Special steel ring P4S-PENG-100

StreamTex NMO

Nylon Monofilament Mesh Filter Bags

Features

- Uniform mesh openings provide precise filtration
- The mesh filaments will not shift or deform under pressure
- Dimensionally stable material provides consistent performance
- FDA compliant

The NMO Nylon Monofilament Mesh Filter bags are constructed using a woven fabric. Each thread is a single filament, providing excellent strength with no fibre migration.

The fabric is designed with evenly spaced apertures, the monofilament yarn used in the fabric is resistant to a broad range of chemicals as well as being extremely abrasion resistant, unaffected by metal fatigue or corrosion, has no loose fibres and boasts high tensile strength.



NMO Nylon Filter bags

Bag Size	Ring Type	Material	Micron Rating Absolute @99%
P1	P = Multi Seal Collar S = Steel ring T = Sewn	Nylon Monofilament Mesh	010, 025, 035,
P2			045, 055, 065,
P2D			075, 100, 125,
P3			150, 175, 200,
P4			250, 400, 600,
P5	800, 1200		

Order example:

Size 1 bag 25 Micron with standard Multi Seal Collar in NMO material = P1P-NMO-025

Size 4 bag 400 Micron with Special steel ring P4S-NMO-400

StreamTex SSM

Stainless Steel Mesh Filter Bags

Features

- Uniform mesh openings provide precise filtration
- The mesh filaments will not shift or deform under pressure
- Dimensionally stable material provides consistent performance

The SSM Stainless Steel Mesh Filter bags are constructed using a woven stainless steel fabric. Each thread is a single filament, providing excellent strength with no fibre migration.

The mesh is designed with evenly spaced apertures, the wires used in the fabric is extremely abrasion resistant, resistant to a broad range of chemical and resistant to high temperatures.



SSM Filter bags, Sewn Seams (PTFE)

Bag Size	Ring Type	Material	Micron Rating Absolute @99%
P1 P2 P2D P3 P4 P5	S = Steel ring	SSM Stainless Steel Woven Wire Mesh	50 -600

Order example:

Size 4 bag 400 Micron with Special steel ring
P4S-SSM-400

CHF

High Flow Pleated Filter Cartridges for bag housings

Features

- Upgrade your bag filter to an Absolute high flow cartridge filter
- Available in two sizes to retrofit size 1 or 2 bag filter vessels
- This pleated cartridge has a unique inside to outside flow pattern

StreamTex CPBH High Flow Pleated Filter Cartridge is a large diameter, coreless single open end pleated cartridge designed to reduce system investment cost and disposal cost via long service life.

Upgrade existing bag filter systems to an Absolute high flow pleated cartridge instantly without altering any piping.



CHF High Flow Pleated Filter Cartridges

Type of Filter	Bag size	Micron rating Absolute @99%	Length	End Fitting
CHF	F= 1 G = 2	0005, 001, 003, 005, 010, 020, 040, 070, 100, 120	11 = 285mm 27 = 685mm	S = Vessels with side entry T = Vessels with top entry

Max. operating temperature 60° C
Max. differential pressure 3 bar
Recommended differential pressure 2 bar

Order example:

Cartridge Size 1, 5 Micron, 285mm long, for vessels with side entry
CHF-F-005-11-S

Applications

- Food & Beverage
- Industrial DI Water
- Chemical industry
- Paint and Coating
- Micro-Electronic industry
- Petrochemical industry

Performance Chart Flow Rate P2 Size

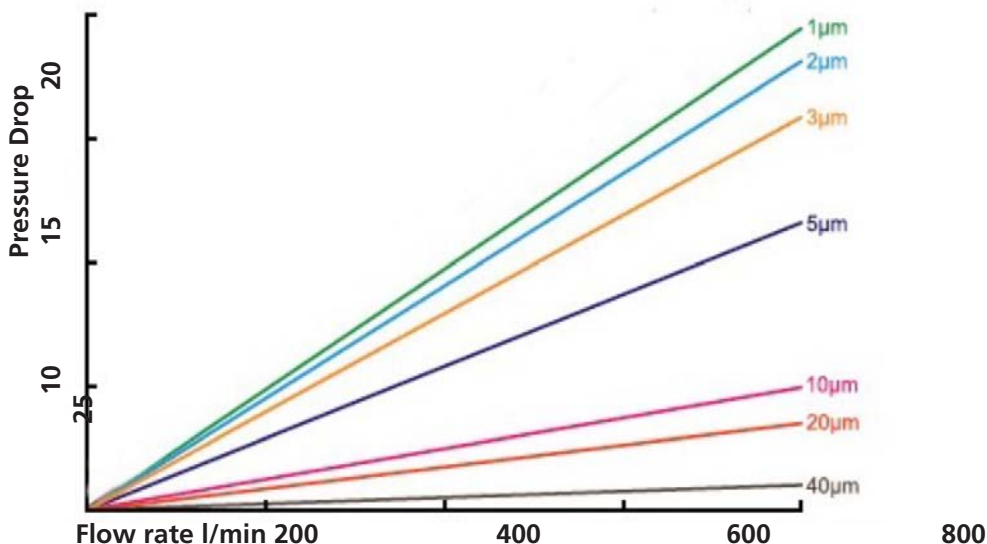

StreamTex Cartridges

Cartridge selection guide

Questionnaire

Criteria	Question	Reason	Answer	Code
Type of product	What is being filtered? Chemical compatibility	Chemical compatibility with filter media		
Operating temperature	Temperature at the filter?	Temperature compatibility with filter media		Deg.C ⁰
Viscosity at temperature	Resistance of fluid to motion?	Selection of filter media type		SG
Particle sizing	What are we removing?	Selection of filter media type		Micron
Cleanliness level required	Micron Rating?	Selection of filter media grade		Micron
Dirt-Loading, Type of dirt	Which filter media type is suitable?	Selection of filter media type		
Flow rate, batch size	Volume processed?	Sizing of filter cartridge/vessels		l/min
System pressure	Pump capability?	Sizing of filter cartridge/vessels		bar
Pipe size	System compatibility?	Sizing of filter vessels		inch, mm
Pipe material quality	System compatibility?	Quality of filter vessel material		SS, MS, Poly
Differential pressure	Difference between 2 pressure points in the system	System sizing		bar

Cartridge filters can be the logical choice for a wide variety of applications with varied flow rates that require sub-micron retention rating, including food and beverage, chemicals, paint and the filtration of acids and bases. Cartridge filtration can also be an effective choice for pharmaceutical and ultra-pure water applications.

Careful consideration, when choosing a liquid filtration system, will offer numerous potential benefits. A wise filter selection can minimize process downtime, reduce or eliminate waste disposal costs, limit worker exposure to the process liquid, reduce maintenance time and expense, and improve product quality.

Filter Fabric Qualities and Suitability

Fabric	Cotton	Polyester	Glass	Nylon	Nomex	Polypropylene	316 SS
Specific Gravity	1.55	1.38	2.56	1.14	1.14	0.9	0.798
Tensile Strength	44-109	64-124	200-215	58-128	58-128	50-85	290-580
Abrasion and Flex	Fair	Very Good	Poor	Excellent	Very Good	Very Good	Excellent
Weak Acids	Poor	Very Good	Excellent	Fair	Fair	Excellent	Very Good
Strong Acids	Poor	Good	Good	Poor	Poor	Excellent	Very Good
Weak Alkali	Excellent	Good	Fair	Excellent	Excellent	Excellent	Very Good
Strong Alkali	Excellent	Poor	Poor	Excellent	Excellent	Excellent	Very Good
Solvent	Good	Good	Excellent	Good	Good	Fair	Very Good
Temperature Deg.C ⁰	90 - 115	135 - 160	260 - 315	135 - 160	205 - 230	90 - 105	450

End Fitting Options

- Type A**
 Single Open End
 Code 7 (226), 70002
 O-Ring Bayonet Lock
 one end and Fin other end
- Type B**
 Single Open End
 Code 8 (222), 70003
 O-Ring Bayonet Lock
 one end and Fin other end
- Type C**
 Double Open End
 with Gaskets
 = STANDARD



StreamTex CSW

String Wound Filter Cartridges

Features

- Choice of Polypropylene, Polyester and Bleached Cotton Media
- High dirt holding capacity
- Effective premium depth filtration
- FDA compliant media

StreamTex CSW series string wound filter cartridges are a premium-performance filtration product.

As a result of combining computer-aided design and state-of-the-art production processes we created exact diamond-shaped depth filtration woven cones.

The unique structured loose outer layers and tight inner layers offer depth filtration that provides high dirt holding capacity for desired cleanliness of end product



CSW String Wound Filter Cartridges

Type of Filter	Dia mm OD / ID	Material	Micron rating	Length inch	End * Fitting
CSW	B = 63/28 E = 115/30	PP Polypropylene FDA compliant	001, 003, 005, 010, 020, 030, 050, 075, 100	9 = 9.75" 10 = 10" 20 = 20" 30 = 30" 40 = 40"	C

Order example:

Cartridge Dia. 63mm, Polypropylene, 50 Micron, 10" long, Blank End Fittings = CSWB-PP050-10C

Applications

- Prefilter for Water Filtration and Purification
- Food and Beverage
- Semiconductor
- Chemical Industry
- Mining
- Mineral Processing

Performance Chart

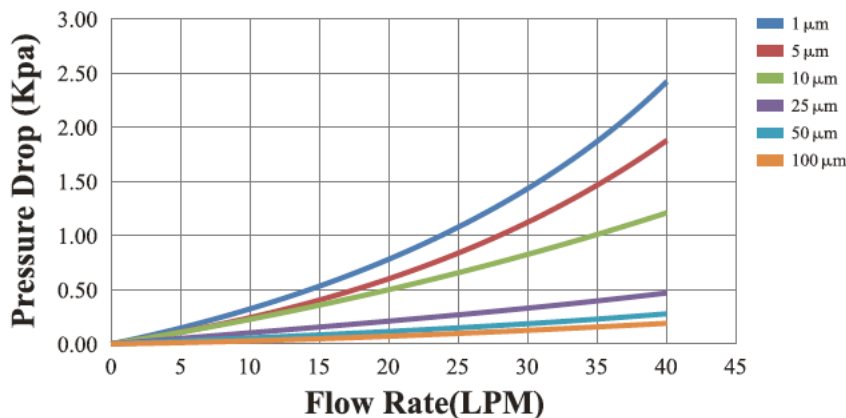

StreamTex CMB

Polypropylene Meltblown Filter Cartridges

Features

- Three internal homogenous layered structure for superior depth filtration
- Excellent dirt holding capacity
- 100% Pure Polypropylene material
- Wide Chemical compatibility
- FDA compliant media

The StreamTex CMB cartridge has three progressive depth structures - the inner fibres are extremely fine and compact to capture fine particulates.

The fibres in the middle and outer areas are larger in diameter with less density and more porosity that provides an excellent low-pressure drop and high contaminant dirt holding capacity properties.

Additionally the CMB cartridge has a higher surface area and non-fibre releasing properties due the melt-blown structure.



CMB Melt Blown Filter Cartridges

Type of Filter	Dia mm	Material	Micron rating	Length inch	End * Fitting
CMB	B = 63	PP Polypropylene FDA compliant	001, 003, 005, 010, 025, 050, 075, 100, 150	9 = 9.75"	A B C
				10 = 10"	
	E = 115			20 = 20"	
				30 = 30"	
				40 = 40"	
				50 = 50"	
				60 = 60"	
				9 = 9.75"	
				10 = 10"	
				20 = 20"	

Order Example

Cartridge 115mm diameter, Polypropylene, 25 Micron, 20" long, with Single open end 222 O-ring/Fin End fitting = CMBB-PO025-20A

Applications

- Pre-Filter for Water Filtration and Purification
- Food and Beverage
- Semiconductor
- Chemical Industry
- Mining
- Mineral Processing

Performance Chart

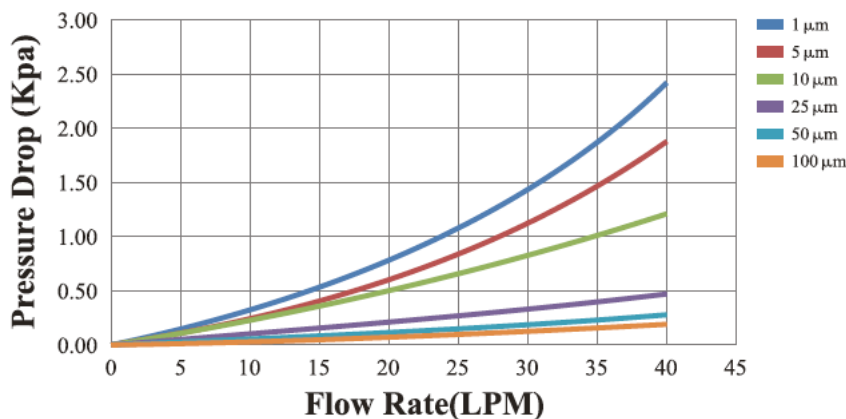

StreamTex CCB / CCF

Activated Carbon Filter Cartridges

Features

- Available as Activated Carbon Block or Carbon Fibre
- Depth Filtration
- Removes heavy metal in water
- Removes odours, can reduce chlorine & chloramine

StreamTex Activated Carbon cartridges are made of high adsorptive carbon powder and granular activated carbon, compressed during extrusion.

This provides superior absorbability and filtration efficiency and offers stable pressure drop combined with long service time.

Activated Carbon cartridges offer an economical solution for your general water filtration needs and industrial process purposes



CCB Activated Carbon Block Cartridges

Type of Filter	Dia. mm	Micron rating	Length	End Fitting Options
CCB	D = 69 E = 115	0005, 001, 005, 010	9.75" 10" 20" 30"	C

CCF Activated Carbon Fibre Cartridges

Type of Filter	Dia. mm	Micron rating	Length	End Fitting Options
CCF	D = 69 E = 115	001, 005, 010	9.75" 10" 20"	C

Order example:

69mm Diameter, 10 Micron, 20" long cartridge
CCBD-010-20D

Order example:

115mm Diameter, 5 Micron, 10" long cartridge
CCFE-005-10D

Applications

- Electro-plating
- Drinking water
- Industrial Water Treatment
- Food & Beverage industry

StreamTex CPL

Nylon 6 Pleated Filter Cartridges

Features

- Hydrophilic Nylon 6 Membrane media
- High flow and low pressure drop through high porosity membrane
- No fibre release
- 100% integrity tested

The StreamTex Nylon membrane cartridge provides wide system compatibility and absolute rated filtration efficiency, yielding the cleanest possible process fluids in a variety of industrial applications.

The naturally hydrophilic nylon membrane cartridges require no pre-wetting and or surfactants.

Each cartridge module is also individually tested for integrity during manufacturing



CPL Nylon 6 Pleated Filter Cartridges

Type of Filter	Dia. mm	Retention Micron rating Absolute	Length	End Fitting Options*	Gasket material	Con-nection rein-forcement
CPL	D = 69	0.1 0.22 0.45 0.65 0.8 1.2	10" 20" 30" 40"	A B	S = Silicone E = EPDM V = Viton	316 SS

Max. operating temperature 80° C
 Max. differential pressure 5 bar at 20° C, 2 bar at 80° C
 Sterilisation: 30 min cycle at 120° C

Order example:

Cartridge 69 mm diameter, 0.1 Micron, 30" long, with 226 Fittings and Silicone Gaskets: CPLD-NY0.1-30AS

Applications

- Pharmaceuticals
- Biopharma
- Veterinary Ethicals
- Food & Beverage
- Semiconductor

Performance Chart

Pressure Drop vs. Flowrate@ 20°C

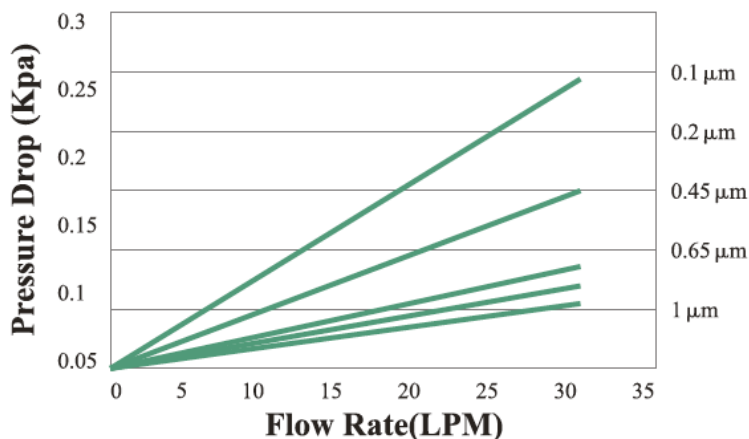

StreamTex CPL

Polypropylene Pleated Filter Cartridges

Features

- High surface area ensures long service life and low initial pressure loss
- Excellent chemical compatibility, suitable for solvent and acid/alkaline applications
- Graded pore density for high dirt holding capacity
- FDA compliant design

StreamTex CPL series Pleated Cartridges deliver high efficiency and consistent filtration for wide range of critical liquid-solid separation applications.

The CPL series cartridge provides particle retention from 0.1 to 50 micron available in nominal or absolute rated cartridges.



CPL Polypropylene Pleated Filter Cartridges

Type of Filter	Dia. mm	Retention Micron rating Absolute	Length	End Fitting Options	Gasket material	Connection reinforcement
CPL	D = 69	0.1	10"	A	S = Silicone E = EPDM V = Viton	316 SS
		0.22	20"	B		
		0.45	30"	C		
		001	40"			
		003				
		005				
		010				
025						

Max. operating temperature 60^o C
 Max. differential pressure 5 bar at 20^o C, 3 bar at 80^o C
 Sterilisation: 5 times 20 min cycle at 120^o C

Order example:

Cartridge 69mm diameter, 5 Micron, 10" long, with Double open End and Viton gasket, Connection reinforced: CPLD-PO005-10AS

Applications

- Pharmaceutical
- Food and Beverage
- Oil & Gas
- Microelectronics
- Chemical Industries
- Pre-filtration for RO
- Paints and coatings
- Cosmetics
- Plating Solutions
- Industrial Water Treatment
- Photographic solution

Performance Chart

Pressure Drop vs. Flowrate@ 20°C

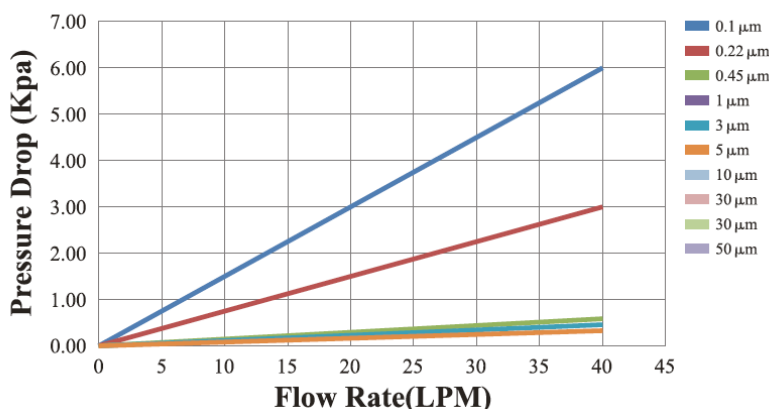

StreamTex CME

PES Membrane Filter Cartridges

Features

- Hydrophilic PES Membrane with high flow capacity
- Excellent chemical compatibility, suitable for solvents and acid/alkaline applications
- 100% integrity tested
- FDA compliant materials

StreamTex CME absolute rated Hydrophilic Polyether-sulfone membrane cartridges are designed specifically for process applications needing high flow and high particle retention characteristics due to the highly asymmetric pore structure of the membrane media.

All cartridges are manufactured in clean room environment using membrane material that has been challenged by 100% integrity test with 18 mega-ohm high purity DI water, and compiles to FDA biological safety standards.



CME PES Membrane Filter Cartridges

Type of Filter	Dia. mm	Retention Micron rating Absolute	Length	End Fitting Options	Gasket material	Connection reinforcement
CME	D = 69	0.1 0.22 0.45 0.65 0.8 1.2	5" 10" 20" 30" 40"	A B	S = Silicone E = EPDM V = Viton	S = 304 SS

Max. operating temperature 80^o C
 Max. differential pressure 5 bar at 20^o C, 2 bar at 80^o C
 Sterilisation: Twenty 30 min cycles at 120^o C

Order example:

Cartridge 69mm diameter, 0.45 Micron, 30" long, with Single open End Code 7 and EPDM gasket, Connection reinforced: CMED-0.45-30AS

Applications

- Pharmaceuticals
- Biopharma
- Veterinary Ethicals
- Food & Beverage
- Semiconductor

Performance Chart

Pressure Drop vs. Flowrate@ 20°C

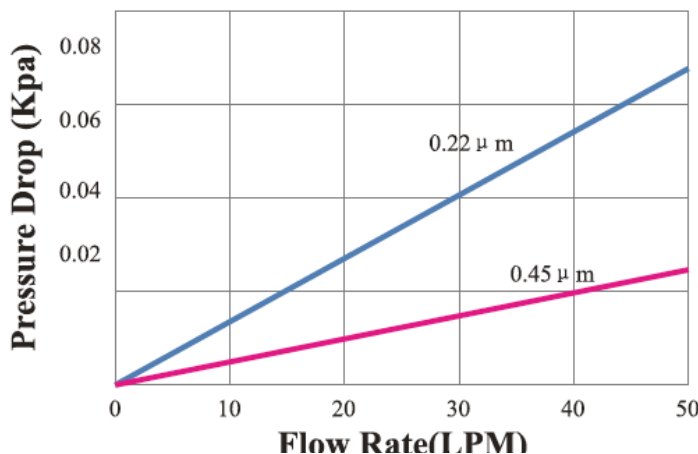

StreamTex CME

PTFE Membrane Filter Cartridges

Features

- Hydrophilic PTFE Membrane media
- High flow rates and optimised surface area reduce processing time and increase service life
- No release of extractables
- 100% integrity tested and testable in-situ

The StreamTex naturally hydrophobic Polytetrafluoroethylene membrane media maintains air flow rates in critical venting and gas applications required by sterile barriers.

Manufactured under strict quality control measures that includes rigorous testing for rinse-up, shedding, flow and extractables levels to ensure CME cartridges exceed industry standards.



CME PTFE Membrane Filter Cartridge

Type of Filter	Dia. mm	Retention Micron rating Absolute	Length	End Fitting Options	Gasket material	Connection reinforcement
CME	D = 69	0.1, 0.22, 0.45, 001, 003, 005, 010, 025	10", 20", 30", 40"	A, B, C	S = Silicone E = EPDM V = Viton	S = 304 SS

Max. operating temperature 80^o C
 Max. differential pressure 5 bar at 20^o C, 2 bar at 80^o C
 Sterilisation: 100 times 30 min cycle at 120^o C

Order example:

Cartridge 69mm diameter, 0.01 Micron, 40" long, with Double open End and Viton gasket, Connection reinforced: CMED-PT00001-40DV

Applications

- Fermentation Vessel gas sparging
- Vent Filter for holding tank
- Microelectronics – ultrapure gas filtration
- Chemical Industries
- Autoclave venting
- Compressed gases
- Photoresist
- Pharmaceutical intermediates
- Hot de ionized (DI) water

Performance Chart

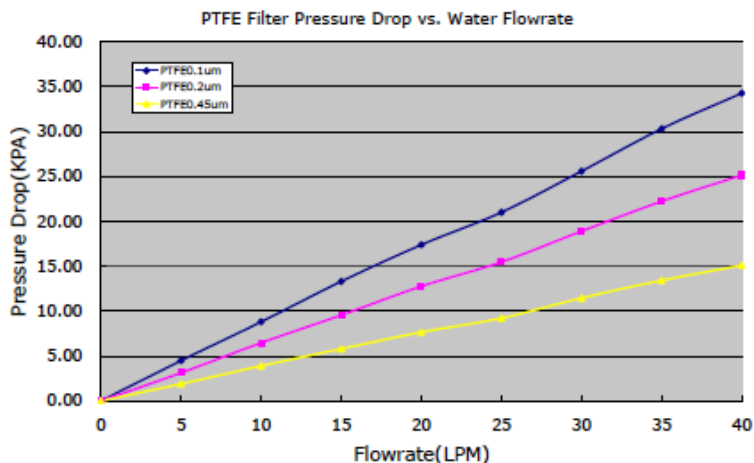

StreamTex CPL / CSI

Pleated- and Sintered Stainless Steel Cartridges

Features

- High surface filtration area
- High operating differential pressure
- High operating temperatures
- Process steam
- Low initial pressure drop
- Re-usable

The StreamTex pleated filter cartridges are made of stainless steel fibre web and stainless steel woven wire mesh.

The StreamTex sintered porous metal filter cartridges are made from fine stainless steel powders sintered to form rugged high voids and fixed pore filters with high-temperature, pressure, and solvent resistance.

These filter elements provide the advantage of high porosity, large filter area and high dirt holding capacity, that can be chemically cleaned or by ultrasonic cleaning method.

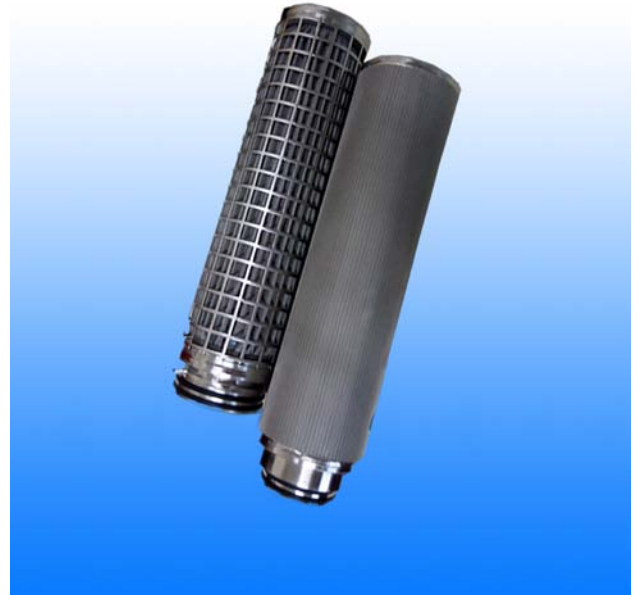

CPL Pleated Stainless Steel Cartridges

Type of Filter	Dia. mm	Retention Micron rating Absolute	Length	End Fitting Options	Gasket material
CPL	D = 69	001 003 005 010	10" 20" 30" 40"	A B C	S = Silicone E = EPDM V = Viton

Max. operating temperature 200^o C
Max. differential pressure 6 bar at 25^o C

CSI Sintered Stainless Steel Cartridges

Type of Filter	Dia. mm	Retention Micron rating Absolute	Length	End Fitting Options	Gasket material
CSI	D = 69	001 003 005 010	10" 20"	A B C	S = Silicone E = EPDM V = Viton

Order example:

Cartridge 69 mm diameter, 0.2 Micron, 10" long, with Single open End, Viton: CPES-A-00002-10-AV

Applications

- High molecular polymer
- Hydraulic Oil
- Hot gas or steam
- Water Treatment

StreamTex CHF

High Flow Polypropylene Pleated Filter Cartridges

Features

- High dirt loading capacity for longer service life reduces cost of filtration and disposal expense.
- Single open-end (SOE) connection configuration for secure by-pass free sealing.
- Absolute filtration, >99.995% efficiency
- FDA compliant materials of construction
- Fits most high flow vessels in the market

The High Flow Pleated Filter Cartridges are made from a polypropylene microfibre membrane using a special pleat technology that provides a very large surface area in one single cartridge element.

This allows to reduce the capital investment required by using smaller vessels to meet the same design flow rate.



CHF High Flow Pleated Filter Cartridges

Type of Filter	Dia. mm	Retention Micron rating Absolute	Length	End Fitting Options
CHF	C = 165	001, 003, 005, 010, 020, 050, 070	20" 40" 60"	C

Max. operating temperature 80° C
 Max. differential pressure 3.4 bar
 Recommended flow rate max. 78m3/hr

Order example:

Cartridge 1 Micron, 40" long with A-Type end fitting
 CPHP-A-001-40-A

Applications

- Pre-filtration of RO
- Sea Water Desalination
- Condensate Water
- Solvent filtration
- Micro-electronics industry

Performance Chart - Filtration Efficiency

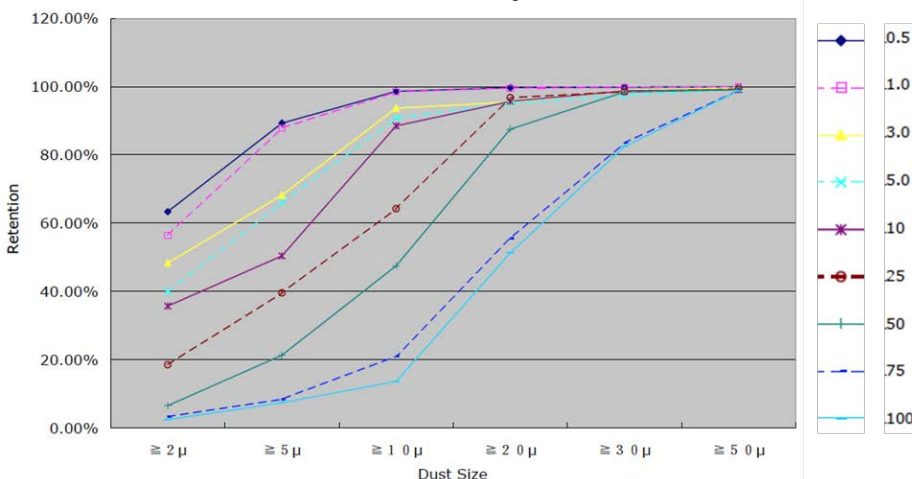

Filter Vessel Selection

Common applications

 <p>Chemical</p>	 <p>Process, Mineral</p>	 <p>Environmental</p>	 <p>Life Science</p>	 <p>Food</p>
<p>Chemical/Petrochemical Industries Monomers, polymers, glycols, herbicides and pesticides, catalysts, product polishing, photoresist, acids, bases, solvents, deep disposal well fluids, inks, adhesives, liquid detergents, dyestuffs, fabric coatings, paper coatings, electroplating solutions, metal etching solutions, automotive paints, can coatings, coil coatings etc</p>	<p>General Process Industries Printing Inks, adhesives, liquid detergents, dyestuffs, fabric coatings, paper coatings, electroplating solutions, metal etching solutions, automotive paints, can coatings, coil coatings, chemicals for film development, oil and polymer filtration, dispersion</p>	<p>Power Generation Makeup water, laundry drain waste water, steam generator blow-down prefilters, filter demineraliser septa.</p> <p>General Service Rinse water, reverse osmosis system prefiltration, water - prior to and/or after demineralisation</p>	<p>Pharmaceutical Small and large volume parenterals, ophthalmics, oral medications, recovery of active ingredients, active carbon purification and removal, filtration of hormones, vitamin extracts, gelatin, protein removal from plasma, filtration of saline solutions</p>	<p>Food & Beverage Bottled water, wine, beer, soft drinks, flavours, storage tank, reactor vents, corn syrup, edible oils, milk and distilled spirits.</p> <p>Fermentation Liquid growth media, makeup water, intermediates, final liquid products, additives</p>

Filter Vessel Types

<p>PVPP Corrosive Applications</p>	<p>PVBS Side Entry</p>	<p>PVBT Top Entry</p>	<p>PVBA Top Entry / Easy bag change</p>	<p>PVHF Side Entry High Flow rates</p>
				
<ul style="list-style-type: none"> • Single bag design • Steel Side entry vessels • High Pressure and Temperature • Flow rates from 300-650 l/min 	<ul style="list-style-type: none"> • Single bag design • Steel Side entry vessels • Cost-effective solution • Flow rates from 55-450 l/min 	<ul style="list-style-type: none"> • Steel Top entry vessels • Minimal headroom required • Easy bag change-out • Flow rates from 115-450 l/min 	<ul style="list-style-type: none"> • Based on our standard PVBT's • 45° design for ease of bag change, reduces OH&S issues • Flow rates from 115-450 l/min 	<ul style="list-style-type: none"> • High flow steel vessel • Most cost-effective solution • Flow rate up to 800 l/min
<p>PVPPM Corrosive Applications</p>	<p>PVFM Multi-Bag/Cartridge</p>	<p>PVBM / PVCM Multi-Bag/Cartridge</p>	<p>PVSC Self-Cleaning</p>	<p>PVSE Pre-Filtration Separator</p>
				
<ul style="list-style-type: none"> • Multi bag design • Steel Side entry vessels • 8 bar pressure rating • Flow rates from 1600-14,000 l/min 	<ul style="list-style-type: none"> • Multi bag or cartridge vessel • Reinforced Fibreglass • 10 bar pressure rating • Flow rates from 3200-28,000 l/min 	<ul style="list-style-type: none"> • Multi bag or cartridge Vessel • From 3 - 200 cartridges or 2-18 bags • Low profile design 	<ul style="list-style-type: none"> • Self cleaning filter • No bags required • 3 Sizes available • Flow rates from 50-750 l/min 	<ul style="list-style-type: none"> • Maintenance free separator • Protects equipment • Cyclone design • Flow rates from 330-5000l/min

Filter Vessel Selection

Vessel Type		Flow Rate l/min, by Filter Media Type			
No of bags per vessel	In-/Out-let size	POMF bags	PENG, PONG bags	NMO bags	High Flow Cartridge
1	2-3"	260	380	470	800
2	3-4"	520	760	940	1,600
3	4-5"	780	1,140	1,410	2,400
4	5-6"	1,040	1,520	1,880	3,200
6	6-7"	1,560	2,280	2,820	4,800
8	8-9"	2,080	3,040	3,760	6,400
10	10"	2,600	3,800	4,700	8,000
11	10"	2,860	4,180	5,170	8,800
12	10"	3,120	4,560	5,640	9,600
14	12"	3,640	5,320	6,580	11,200
16	12"	4,160	6,080	7,520	12,800
18	12"	4,680	6,840	8,460	14,400

Flow by Vessel Type

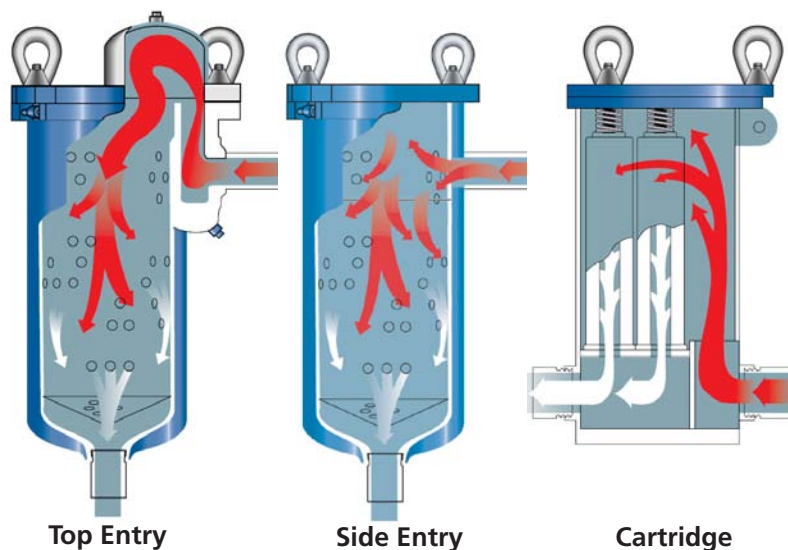

In most filtration applications, fluid viscosities do not exceed 50 cps. Using the Flow Rates shown in the table per #2 Size Bag at 5 Micron as a guide, and using a specific gravity of 1 (Water) the suggested flow rates should result in a CLEAN Pressure Drop under 2 PSID.

Selection Guide / Specifications

	Models	PVBS	PVHF	PVBT / PVBA	PVBA	PVBM	PVPP	PVPPM	PVSC	PVSE	PVCM
	Series	Side Entry	High Flow	Top Entry	45 Deg	Multi Bag	Poly	Poly	Self-Cleaning	Separator	Cartridge
SPECIFICATIONS	Material	304/316	304/316	304/316	304/316	304/316	PP	PE	304/316	304/316	304/316
	Temperature Range	90 C	90 C	90 C	90 C	90 C	60 C	60 C	90 C	90 C	90 C
	Filter bag size	1, 2	2	1, 2	2	2	2, 5	2	n/a	n/a	n/a
	Number of bags / Cartridges	1	1	1	1	2 - 18	1	8	n/a	n/a	6 - 200
	Filtration surface area in m2	1 = 0.19 2 = 0.45	0.45	1 = 0.19 2 = 0.45	0.45	0.9 - 8.1	5 = 0.19 2 = 0.45	0.45	n/a	n/a	
	Flow rates l/min	55 - 450	800	115 - 450	115 - 450	900 - 8,100	300 - 650	1600 - 14,000	50 - 750	330 - 5,000	20 - 10,000
	Inlet / Outlet size	2"	3"	2"	2"	3" - 12"	2"	DN250	1.5"-3"	2" - 10"	3" - 12"
FILTRATION GRADE	Coarse filtration > 500 um	X	X	X	X	X	X	X	X	X	X
	Medium filtration > 25 um	X		X	X	X	X	X	X	X	X
	Fine Filtration > 10 um	X	X	X	X	X	X	X			X
	Very Fine filtration < 10 um	X	X	X	X	X	X	X			X
FILTRATION MEDIA	Acids, bases	X		X	X	X	X	X	X		X
	Catalyst, Act. Carbon	X		X	X	X					X
	Fats & oils	X		X	X	X		X			X
	Petrochemical	X		X	X	X		X			X
	Solvents, Paints	X		X	X	X		X			X
	Water, Waste Water	X	X	X	X	X	X	X	X	X	X
FILTER MEDIA	NMO Mesh	X	X	X	X	X	X	X			
	SSM Stainless Steel Mesh	X	X	X	X	X	X	X			
	PONG Felt	X	X	X	X	X	X	X			
	PENG Felt	X	X	X	X	X	X	X			
	POMF Microfibre	X	X	X	X	X	X	X			
	CHF High Flow PP Cartridges		X								
	Cartridges										X

PVPP

Polypropylene Pressure Vessels

Features

- 100% Polypropylene Construction
- Easily convertible from bag filter to cartridge filter
- Twist off lid design for quick and easy change-out
- Side inlet/outlet eliminates sump to reduce waste
- Hermetic sealing of filters result in no fluid bypass
- FDA compliant

Different industrial applications can have different requirements in terms of equipment and filter media. The PVPP filter housing is highly adaptable to precisely fit your particular needs. This strong, light weight and economical filter vessel is resistant to a wide range of chemicals, and converts easily from filter bag usage to cartridge filters. It allows the user to choose the filter media and constructions to precisely fit their particular needs. The PVPP is manufactured from Polypropylene with a UV inhibitor for all-weather durability. Tool less opening and closing of threaded lid with perfect seal.

PVPP Convertible Filter housings

Pressure Vessel	Design Type	Entry	Bag Size	Material	Flange Type
PV-PP	B = BAG C = CARTRIDGE	S = Side	2 5	PP = Polypropylene	A = ANSI B = BSP
CE Certified, Design operating temperature 43 ^o C Operating pressure 100 PSI / 6.9 bar at 43 ^o C					



Pressure Vessel Size	Recommended operating pressure max	Max. operating temp.	Max. flow rate	Bag Type	Bag size	Flange	Mounting method	Weight
5	6 bar	80 deg C	18 m3/hr	No 5	6" x 20"	2"	Legs	7.0 kg
2	6 bar	80 deg C	40 m3/hr	No 2	7" x 32"	2"	Flange	12.0 kg

The PVPP Series pressure vessel has been designed for easy cleaning with no metallic parts that can rust or corrode to potentially pollute the product. This housing provides reduced bag change-out time without the need for tools therefore providing minimal process interruption.

The PF design is totally flexible when considering process connection with one outlet as a possible drain port for product recovery for safe disposal/reuse.

Vessel sizing / System configuration

*Maximum flow rate is based on aqueous flow at ΔP=1.0psi clean through filter only without bag installed. Achieved flow rate is dependant on type of fluid being filtered, fluid viscosity and temperature, micron rating and type of filter bag. Please consult one of our product specialists when sizing these vessels

PVPPM

Multi-Bag HDPE Pressure Vessels Side Entry - Quick bag change design

Features

- Designed for easy and efficient bag change
- High density Polyethylene vessel
- Resistant to corrosion and chemicals
- Able to handle very high flow rate and high dirt holding capacity

The StreamTex side inlet bag filter is designed for efficient filtration and easy change of bags. The quick opening feature and special davit cover allow for easy and bag changes without the need for any tools.

The housing is made from high density polyethylene HDPE, is corrosion free and resistant to chemicals.

A cost-effective solution to suite a wide range of applications. We can customise it to fit your individual requirements with flow rates up to 580 m³/h.



PVBS Multi-Bag Pressure Vessels

Model	No and type of bags	Vessel Material	Inlet/Outlet	Flange Type	Weight
PV-BS	3 - 7 bag designs	HDPE	DN250 280mm	DIN	440 - 600 kg

Max. operating pressure 8 bar, max. operating temp. 65^o C



Dimensions

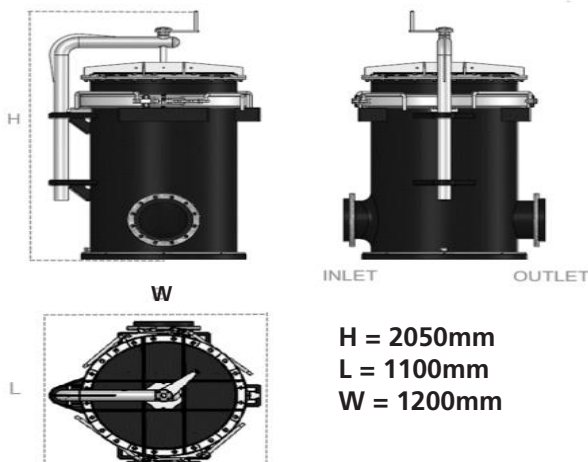

PVBM Flow Chart

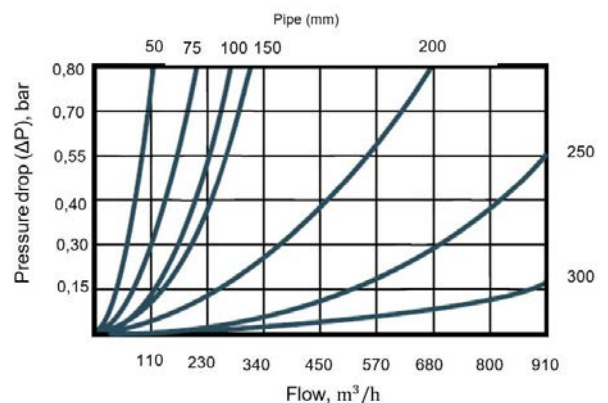

Vessel sizing / System configuration

*Maximum flow rate is based on aqueous flow at $\Delta P=1.0$ psi clean through filter only without bag installed. Achieved flow rate is dependant on type of fluid being filtered, fluid viscosity and temperature, micron rating and type of filter bag. Please consult one of our product specialists when sizing these vessels

PVBS

Steel Pressure Vessels Side Entry - Versatile universal design

Features

- Versatile design sizes for duty convenience
- Swing eye-bolt closure construction for safe operation and maintenance
- Unique design for perfect bag sealing
- To suit all standard bags

The StreamTex durable bag filter design provides the convenience in handling filtration processes, a safety focus easy opening mechanism with bag filter fixing ring to ensure good sealing for both plastic collar fully welded filter bags and sewn felt or NMO filter bags.

The PVBS vessel is suitable for general filtration requirements in most industrial applications with liquid of low to medium viscosity



PVBS Filter Housings

Model	Size / No. of bags	Vessel material	Inlet/Outlet	Flange Type
PV-BS	2 = 1 x #2	304 = 304SS 316 = 316SS	02 = 2"	A = ANSI B = BSP



PVBS Flow Chart

Model	Filter bag surface area	Max. Flow rate	Pressure Rating max
PV-BS1	0.19 m ²	225 l/min	10 bar at 90° C
PV-BS2	0.45 m ²	450 l/min	10 bar at 90° C
PV-BS3	0.05 m ²	55 l/min	21 bar at 90° C
PV-BS4	0.10 m ²	115 l/min	21 bar at 90° C

Order example:

PVBS Vessel for No. 2 bag in 304SS with 2" BSP inlet/outlet configuration = PV-BS1-304-2BI

Gasket materials are available in Buna, EPR, Viton, Viton Teflon Encapsulated, Buna White FDA.

A heating jacket design is available as an option for high temperature processing application

Vessel sizing / System configuration

*Maximum flow rate is based on aqueous flow at ΔP=1.0psi clean through filter only without bag installed. Achieved flow rate is dependant on type of fluid being filtered, fluid viscosity and temperature, micron rating and type of filter bag. Please consult one of our product specialists when sizing these vessels

PVBT

Steel Pressure Vessels Top Entry - Best bag sealing for most challenging applications

Features

- Provides the best seal design
- Precision engineered cast head to reduce pressure loss whilst delivering robust construction
- Ease of cleaning post batch processing
- ASME Design
- To suit standard bags and High Flow cartridges

The StreamTex top inlet bag filter is designed to give perfect 360 degree sealing of a plastic collar fully welded type filter bag.

The bag sits inside the filter clamped by the combined lid with inlet to ensure absolute no bypass.

This provides exceptional performance in the most challenging liquid filtration processes and the best seal design suitable for critical filtration demands in food and beverage, pharma and biopharma industries.



PVBT Filter Housings with Top Entry

Model	No and type of bags	Vessel Material	Inlet/Outlet	Flange Type
PV-BT	2 = 1 x #2 1 = 1 x #1	304 = 304SS 316 = 316SS	2"	A = ANSI B = BSP
Operating pressure 150PSI / 10.34 bar				



PVBT Flow Chart

Model	Filter bag surface area	Max. Flow rate
PVBT-1	0.19 m ²	225 l/min
PVBT-2	0.45 m ²	450 l/min

Order example:

PV Vessel for No. 4 bag in 316SS with 3" BSP inlet/outlet configuration = PV-BT4-316-3B-I

Gasket materials are available in Buna, EPR, Viton, Viton Teflon Encapsulated, Buna White FDA

Vessel sizing / System configuration

*Maximum flow rate is based on aqueous flow at $\Delta P=1.0$ psi clean through filter only without bag installed. Achieved flow rate is dependant on type of fluid being filtered, fluid viscosity and temperature, micron rating and type of filter bag. Please consult one of our product specialists when sizing these vessels

PVBA

Steel Pressure Vessels Top Entry - 45° Ergonomic Design

Features

- Based on our standard PVBT range of pressure vessels
- 45° design for ease of bag changes
- Reduces OH&S issues
- Sanitary finish available
- ASME Design
- Suits standard bags and High Flow Cartridges

The StreamTex top inlet bag filter with 45° design was developed to assist with WHS related issues in the process of regular bag changes.

The angle allows for easy removal of the bags with a lot less strength required to lift the bags out of the vessels. The special design of the lid with an integrated locking mechanism adds further safety to the operators.



PVBA Filter Housings with Top Entry

Model	No and type of bags	Vessel Material	Inlet/Outlet	Flange Type	Finish
PVBA	2 = 1 x #2	304 = 304SS	2"	A = ANSI B = BSP T = Tri-Clover	P = mechanical polish
Operating pressure 150PSI / 10.34 bar					



Order example:

PV 45° design Vessel for No. 2 bag in 304SS with 2" BSP inlet/outlet configuration and Tri-Clover closure = PV-BA2-304-2T-I

Gasket materials are available in Buna, EPR, Viton, Viton Teflon Encapsulated, Buna White FDA

Vessel sizing / System configuration

*Maximum flow rate is based on aqueous flow at $\Delta P=1.0$ psi clean through filter only without bag installed. Achieved flow rate is dependant on type of fluid being filtered, fluid viscosity and temperature, micron rating and type of filter bag. Please consult one of our product specialists when sizing these vessels

PVHF

High Flow Pressure Vessel

Features

- Versatile design sizes for duty convenience
- Swing eye-bolt closure construction for safe operation and maintenance
- Unique design for perfect bag sealing
- Suits all standard bags & High Flow Cartridges
- Non-Code design

The StreamTex durable bag filter design provides the convenience in handling filtration processes, a safety focus easy opening mechanism with bag filter fixing ring to ensure good sealing for both plastic collar fully welded filter bags and sewn felt or NMO filter bags.

The PVHF vessel is suitable for general filtration requirements in most industrial applications with liquid of low to medium viscosity



PVHF Filter Housings

Model	Size / No. of bags	Vessel material	Inlet/Outlet	Flange Type	Design Temp.
PVHF	2 = 1 x #2	304 = 304SS	02 = 3"	A = ANSI	-6 -260 ^o C



PVHF Vessel for No. 2 bag in 304SS with 2" BSP inlet/outlet configuration = PV-BS1-304-2BI

Gasket materials are available in Buna, EPR, Viton, Viton Teflon Encapsulated, Buna White FDA.

A heating jacket design is available as an option for high temperature processing application

Vessel sizing / System configuration

*Maximum flow rate is based on aqueous flow at $\Delta P=1.0$ psi clean through filter only without bag installed. Achieved flow rate is dependant on type of fluid being filtered, fluid viscosity and temperature, micron rating and type of filter bag. Please consult one of our product specialists when sizing these vessels

PVBM

Multi-Bag Steel Pressure Vessels Side Entry - Overview

Overview

StreamTex is able to offer multi bag vessels for applications requiring high flow rates or a large filtration surface area. Flow is split equally through each filter bag ensuring an even distribution of solid loading. Filter bags are individually held in position by three point locking bayonets, which compress the filter bag ring and produce a seal with the filter vessel.

The vessel lid has a counterbalanced spring assisted lifting mechanism ensuring that opening and closing the filter is safe and easy for operators.

The counterbalance is precise and gives the lid a practically weightless feel. As an additional safety feature, a simple locking system is fitted on the hinge as standard and can be engaged when the lid is in the fully open position.

Multi bag vessels are provided with a choice of two closure types, either a bolted lid or with a quick closure clamp.

Quick closure system

The quick closure system was developed for multi bag vessels to eliminate the need for swing bolts, decreasing the time required for filter bag changeout. The system consists of a heavy-duty precision-engineered clamp, an opening wheel with counter screw, and a safety lock attached to a ball valve fitted to the vent of the housing.

To change the filter bags, first the safety lock is released, simultaneously venting the filter housing. Turning the hand wheel then opens the clamp. The hinged lid can then be lifted and the filter bags changed. The reverse procedure is carried out to close the housing.

Design

Multi Bag Vessels are designed to be ergonomic. A tangential bottom outlet minimises vessel height, reducing the installation space and providing operators with a convenient bag changeout height.

There are several standard inlet and outlet orientations

STYLE 3: Side inlet / tangential bottom outlet on the opposite side.

STYLE 4: Side inlet / tangential bottom outlet on the same side. The hinged lid design minimises the installation floor space required compared to traditional davit lid models. micron rating and type of filter bag.



Operating information

The standard pressure rating is 10 bar, the standard temperature rating is 90C. Higher temperature ratings are available on request. Multi bag vessels can be ASME marked if required.

Optional features are available to meet all customer requirements such as alternative inlet and outlet orientations, heating jackets and many more.

*Maximum flow rate is based on aqueous flow at $\Delta P=1.0$ psi clean through filter only without bag installed. Achieved flow rate is dependant on type of fluid being filtered, fluid viscosity and temperature, micron rating and type of filter bag.

PVBM

Multi-Bag Steel Pressure Vessels Side Entry - Versatile universal design

Features

- Cost-Effective solution
- Perfect bag to housing sealing, no by-pass
- Able to handle very high flow rate and high dirt holding capacity
- Rugged, reliable
- ASME Design

The StreamTex top inlet bag filter is designed to give perfect 360 degree sealing of a plastic collar fully welded type filter bag.

The bag sits inside the filter clamped by the combined lid with inlet to ensure absolute no bypass.

This provides exceptional performance in the most challenging liquid filtration processes and the best seal design suitable for critical filtration demands in food and beverage, pharma and biopharma industries.



PVBM Multi-Bag Pressure Vessels

Model	No and type of bags	Vessel Material	Inlet/Outlet	Flange Type
PV-BM	2 = 3 x #2	304 = 304SS	3"	A = ANSI D = DIN
	4 = 4 x #2		4"	
	5 = 5 x #2		5"	
	6 = 6 x #2		6"	
	8 = 8 x #2		8"	
	10 = 10 x #2		10"	
	11 = 11 x #2		10"	
	12 = 12 x #2		10"	
	14 = 14 x #2		12"	
	16 = 16 x #2		12"	
18 = 18 x #2	12"			
Operating pressure 150PSI / 10 bar				



Order example:

PVBM 6 bag Vessel for No. 2 bag in 304SS with 4" DIN inlet/outlet configuration = PV-BM6-304-4DI

Gasket materials are available in Buna, EPR, Viton, Viton Teflon Encapsulated, Buna White FDA.

Available as option:

Heating jacket design for high temperature processing application. Hydraulic-assisted davit cover, please contact us for more details.

Vessel sizing / System configuration

*Maximum flow rate is based on aqueous flow at $\Delta P=1.0$ psi clean through filter only without bag installed. Achieved flow rate is dependant on type of fluid being filtered, fluid viscosity and temperature, micron rating and type of filter bag. Please consult one of our product specialists when sizing these vessels

PVSE

Maintenance Free Separator

Features

- Ideal for Cooling Tower and Water Treatment applications
- Protection of pumps and heat exchangers
- Maintenance free separation of suspended solid particles in water of up to 10 Micron
- Cyclone design for automatic separation
- High Flow Rates

The Stream- Tex design is based on the technology used in refining industry and is maintenance free. Requiring no back wash and capable of flows up to 250 m3/hr.

Typical application is in cooling towers and in the water treatment industry where solids that accumulate are washed off with minimum amount of filtered water.

From experience in circular cooling tower water application, turbidity reduced significantly from 16 to 7 NTU and suspended solids content from 60 mg/l down to 3 mg/l after one week.



PVSE Separators

Model	Vessel Material	Flange Size	Flange Type	Flow rate m3/hr
PV-SE	304 = 304SS	2"	A = ANSI	20
		3"		40
		4"	D = DIN	100
		5"		160
	316 = 316SS	6"		180
		8"		240
		10"		300
		Operating pressure 10 to 16 bar		

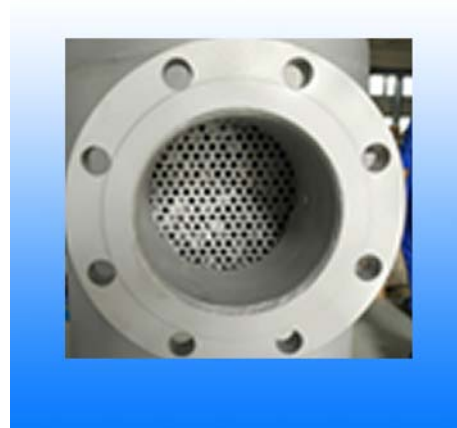

Order example:

PV Vessel for in 304SS with 4" DIN Flange
= PV-SE-304-4D

Vessel sizing / System configuration

*Maximum flow rate is based on aqueous flow at $\Delta P=1.0$ psi clean through filter only without bag installed. Achieved flow rate is dependant on type of fluid being filtered, fluid viscosity and temperature, micron rating and type of filter bag. Please consult one of our product specialists when sizing these vessels

PVSC Series Self Cleaning Mechanical Filters

Specification

- Material 304 or 316 grade Stainless Steel
- Flange types ANSI, JIS and DIN available
- Pressure rating 10 bar
- Three filter sizes available

Applications

- Pulp & Paper Mills
- Food Processing
- Water Wells
- Steel Mills
- Chemical Processing
- Parts Washing

Sizing Guide

Liquid Type	Viscosity CPS	Model PV-SC 1.5	Model PV-SC 2	Model PV-SC 3
		max. flow rates l/min *		
Water	1	50	200	750
Adhesive	10,000-50,000	15	65	200
Edible Oils	10 - 100	50	200	750
Honey	50 - 100	50	200	750
Ink, oil based	100 - 1000	50	200	750
Ink, water based	10 - 100	50	200	750
Paint	500 - 1,000	50	200	750
Resin	5,000-50,000	15	65	200

* Based on retention of 50 Micron or greater
Max. flow based on max. of 500 ppm of solids to be removed.

Pipe Size

Model	UMCF-4	UMCF-8	UMCF-16
Pipe Size	1.5"	2"	3"



Order example:

PV Vessel in 304SS with 3" DIN Flange
= PV-SEC-304-3D

Vessel sizing / System configuration

*Maximum flow rate is based on aqueous flow at $\Delta P=1.0$ psi clean through filter.
Achieved flow rate is dependant on type of fluid being filtered, fluid viscosity and temperature, micron rating and type of filter bag. Please consult one of our product specialists when sizing these vessels

PVSC Series Self Cleaning Mechanical Filters

Simple, Effective and Continuous Filtration

Features & Benefits

- Self cleaning filter system, fully automated
- Ideal for high viscosity, high dirt loading and abrasive liquids applications
- Eliminate high running costs of disposable type filter cartridges and filter bag systems
- Constant and low pressure differential filtration
- No downtime to change bags, increase filter productivity
- No manual handling of used filter bags
- Small footprint

Working Principle

Our mechanical clean filter system is designed to handle to filter particles 25 micron and larger in various industries where high particle content, viscous and sticky liquids are present which other systems can't handle.

PVSC filters are ideal for continuous and batch applications.

The filtration system uses dual pneumatically driven activators to move the special grade Teflon disc up and down the screen to perform the cleaning operation inside of the vertically slotted wedge or perforated screen.

The system can either be operated in manual or automatic mode. The collected dirt is periodically purged in intervals of less than 1-2 seconds to minimise product losses during operation.



A cleaning disc is moving up and down the screen surface to remove the dirt which then can be discharged through the drain valve at periodical times.

The cleaning- and discharge frequency can be programmed using the integrated PLC to suit the individual requirements.

Alternatively the system can be operated manually.

The cleaning disc is made from a special grade of Teflon with a dual edge system, one side for cleaning and the other side for wiping.

The cleaning disc is firmly pressed against the inner screen by a mechanical system.



PVCM Multi Cartridge Pressure Vessels

Specification

- Material 304 or 316 grade Stainless Steel
- Models to suit from 3 up to 200 cartridges
- Low profile design
- Unique spring lifting lid, allows one operator to conduct changeouts

Applications

- Bio-Pharmaceuticals
- Food & Beverage
- Microelectronics liquid filtration



Description

StreamTex Cartridge Filter Vessels are available in single, duplex, and multi-cartridge configurations capable of holding up to 200 or more cartridges.

Cartridge filters are usually disposable but they are also available in washable metal media. Cartridges are available in 10" to 60" length. Standard cartridge diameters are 63mm and 69mm.

End configuration of cartridges can be either double open end (DOE) or single open end with flat closed end or with a fin. Open end can be with 222 or 226 style O ring.

Cartridges are available in 0.1um to 200um and can be nominal or absolute rated for particle removal efficiency, for more details please see our range of standard cartridges on pages 13-22.

Working method

Unfiltered fluid enters the cartridge filter housing and is distributed evenly around the cartridges, from outside to inside. Solids are collected on the outside for easy removal. The filtered fluid then exits through the outlet pipe.

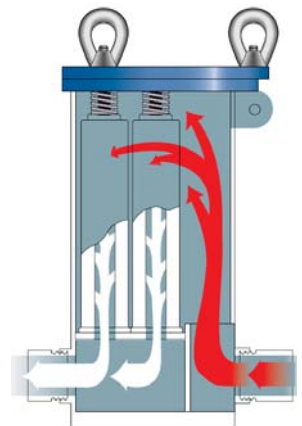

Vessel sizing / System configuration

*Maximum flow rate is based on aqueous flow at $\Delta P=1.0$ psi clean through filter only without cartridges installed. Achieved flow rate is dependant on type of fluid being filtered, fluid viscosity and temperature, micron rating and type of filter bag. Please consult one of our product specialists when sizing these vessels

StreamTex PVFM

Flow Meter and Bag Replacement Timing Indicator

Specification

- Flow Meter and Check valve in one unit
- Very high accuracy of 97.9%
- Clear, easy to read scale in liters per minute
- Easy installation, no calibration required
- Solid design, 1 year breakage warranty

Applications

- To suit pipe sizes up to 2"
- To suit flow rates from 75 - 415 l/min
- Easy to install and maintain
- Filter bag change requirements can easily be checked using the Flow Meter without the need to open the filter vessel



StreamTex Flow Meter

Model	No	Material	Inlet/Outlet	Flow Rate l/min	Thread Type
PVFM	2	Polycarbonate ABS	2"	35-415	B = BSP

Operating pressure max. 3.45 bar (50 psi), operating temperature from 0 - 60°C

All StreamTex PVFM models offer highly accurate performance and a unique ability to be installed right next to other plumbing fittings such as tees, without the need for long straight pipe runs before and after.

They can also be installed horizontally, vertically, or even upside-down.

Order example:

Flow meter to suit 2" BSP pipe = PVFM-2-B

Easy to read scale and visual, red indicator.

Description

The StreamTex Flow meter is a revolutionary, affordable and highly accurate flow meter that guarantees you will know the flow. In addition it also serves as a fully functioning check valve. As flow increases and decreases, the check valve's flippers swing within its range of motion.

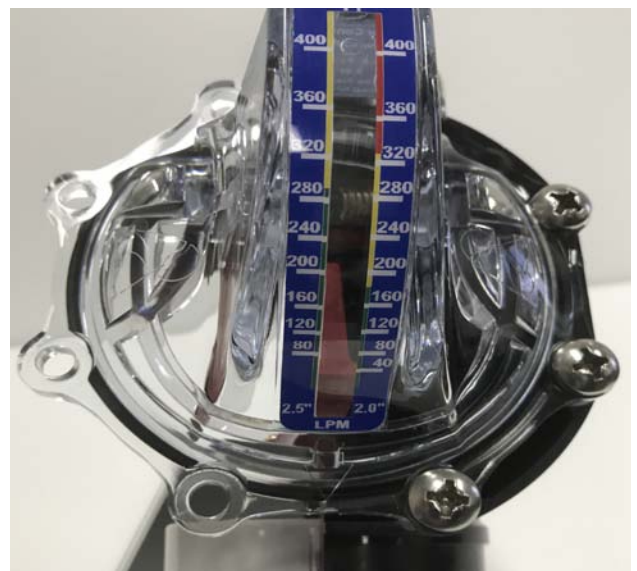
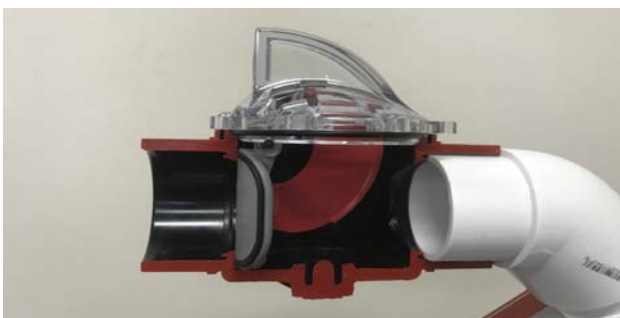

StreamTex Accessories

Accessories for Pressure Vessels

Overview







- Strainer Baskets
- Adaptor heads
- Gaskets, O-Rings
- Magnets
- Evacuation Floats
- Flow Meter

We are able to supply a wide range of bag filter accessories to complement our range of filter vessels.

Selecting the correct accessories such as evacuation floats, magnets or high capacity strainer baskets can reduce fluid wastage and increase filtration performance.

Please consult one of our product specialists to assist you with the right selection of accessories to suit your equipment and requirements.

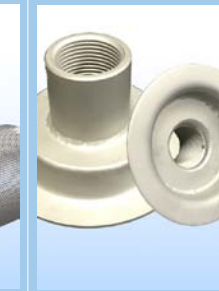

Evacuation Float	Magnets	O-Rings, Seals	Strainer Baskets	Bag Adaptors	Gauge, Flow Meter
					
<ul style="list-style-type: none"> • Displace liquid in the vessel ensuring easier bag changes • Reduces product wastage • To suit most standard bag housings 	<ul style="list-style-type: none"> • Magnetic particles form process liquid adhere to the bar • Filter bag lifetime is prolonged by reducing the amount of solids collected in the bag • Reduced surface abrasion of filter bags caused by sharp particles • To suit standard #2 bags 24" long 	<ul style="list-style-type: none"> • Depending on the product to be filtered, Stream-Tex filter vessels can feature a variety of O-rings 	<ul style="list-style-type: none"> • Based on our standard PVBT's 45° design for ease of bag change, reduces OH&S issues • Flow rates from 115-450 l/min 	<ul style="list-style-type: none"> • Adapter Heads are available in a variety of pipe size and materials to be used with steel ring bags in an open filter system. • Adapter heads are ideal for applications where vessels are impractical. 	<ul style="list-style-type: none"> • Pressure gauges in Stainless Steel to measure differential pressure in the system • Flow meters to indicate reduced flow due to bag

StreamTex PSSI

Simplex Strainer

Specification

- Quality Simplex Strainer
- Available in Mild Steel, Stainless Steel 304 and 316 grade
- Two cover closing choices (bolt, eyelets)
- Solid design, cost effective

Applications

- Quality Simplex Strainer
- Protects system components such as flow meters, pumps and spray nozzles from blocking
- Particles are captured in the strainer basket



StreamTex Simplex Strainer

Model	Material	Flange Size	Pressure Rating	Flange Type	Mesh Lining Micron	Perforated Plate
PVFM	304 = 304SS	2" - 48"	150 300 600 900 1500	A = ANSI	25, 50, 80, 100, 200, 300, 400, 600, 800	3, 5, 8, 10 mm
	316 = 316SS			D = DIN		
	MS = Mild Steel					

Order example:

Strainer in 316SS, 12" flange, 300 psi, DIN, 50 Micron mesh with 5mm perforated plate backing:

PSSI-316-12-300D-50-5

Cover closure types

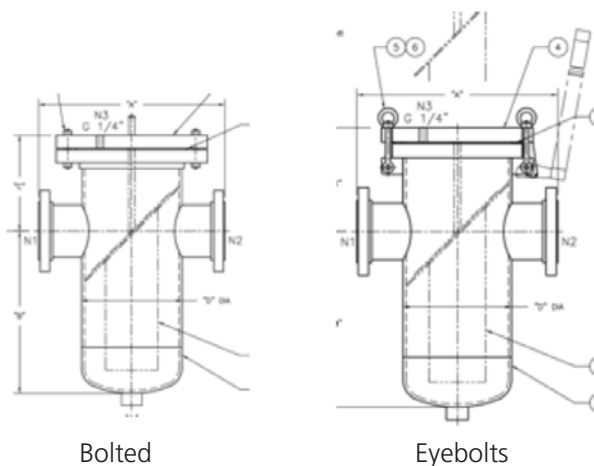

Sefar

Local service - local manufacturing

Technical assistance and Service

- Full Lab facilities for detailed media analysis
- Material Testing facilities
- Vessel selection service
- Filter media selection
- System design assistance

With our extensive experience in the process filtration industry and using our local test lab facilities we have the ability and equipment to design a system for you to suit your individual process application.

Sefar Local Manufacturing

- Custom made designs
- Application specific modifications
- Fast turnaround times
- Consistent quality
- Quality Certification ISO 9001:2015
- State of the art Manufacturing facilities in Sydney NSW and Auckland NZ



We can also integrate custom made labels, colour coding or other designs that can assist your quality requirements by ensuring the right filter bag is used for each process step.



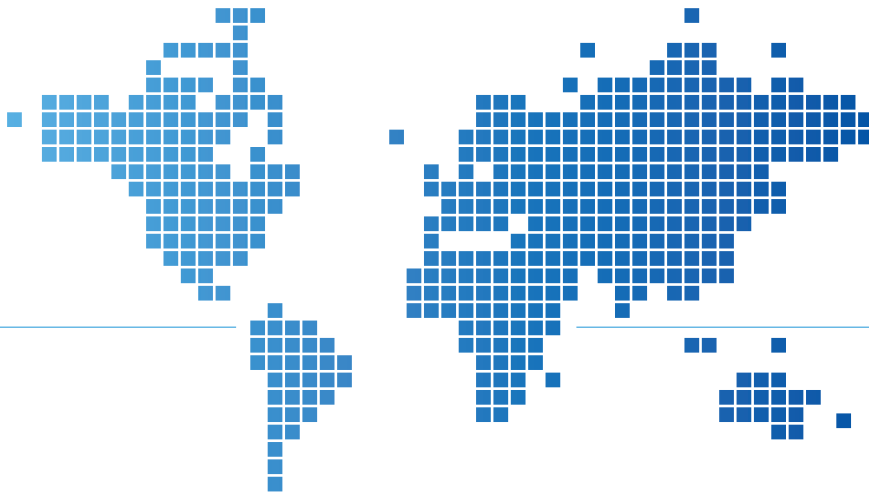

Sefar worldwide

Sefar is the leading manufacturer of precision fabrics from monofilaments for the screen printing and filtration market. Sefar products are used in a wide variety of industries, reaching from electronics, graphics, medical, automotive, food and pharmaceutical applications to aerospace, mining & refining and architecture. With its profound understanding of the applications Sefar helps its customers to achieve optimum results in their industrial processes. Subsidiaries and fabrications centers in 25 countries on 5 continents provide local technical service for the broad range of solutions offered by Sefar.

Headquarters

Switzerland Sefar AG

Hinterbissastrasse 12
CH-9410 Heiden
Ph +41 71 898 57 00
Fax +41 71 898 57 21
filtration@sefar.com
www.sefar.com

Australia & New Zealand

NSW, VIC, QLD, SA, TAS, NT, ACT

Sefar Pty Ltd
19-21 Huntingwood Dr
Huntingwood NSW 2148
Phone +61 1300 306 661
oceaniasales@sefar.com
www.sefar.com.au

WA

Sefar Pty Ltd
2/14 Bally Street
Landsdale WA 6065
Ph +61 8 9303 2600
saleswa@sefar.com
www.sefar.com.au

New Zealand

Sefar Ltd
24G Allright Place
Mt Wellington
Auckland 1060
Ph +64 9527 4410
salesnz@sefar.com
www.sefar.nz

Product range

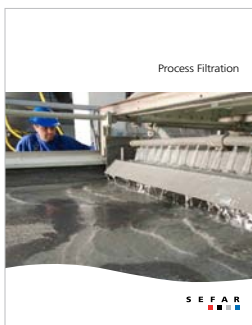

Process Filtration

- Vacuum Belt Filters
- Rotary Drum Filters
- Rotary Disc Filters
- Belt Press Filters
- Filter Press
- Horizontal disc filter
- Leaf Filter
- Tube Press Filter
- Candle Filters
- Batch Filters

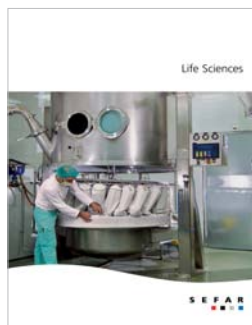

Life Sciences

- Fluid Bed Dryer bags
- Connector Sleeves
- Bowl screens
- Pharma screens
- Strainer bags
- Centrifuge liners +bags
- Nutsche & dryer bags
- Vent-off dryer bags
- Filter discs

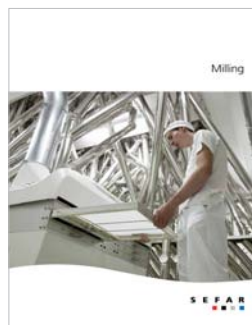

Food & Beverage

- Nylal Sifter screens
- Dust filter bags
- Centrifuge sifter covers and liners
- Connector sleeves
- Milling accessories
- Belts for food processing



Metal Mesh

- Woven wire mesh
- Bolting cloth
- Hollander weave
- Welded mesh
- Perforated metal
- Rotex screens
- Kason screens
- Cylinders / Strainers
- Discs



Dry Filtration

- FoodTec filter bags for the food industry
- PM-Tec high temp. filter media
- BWF Envirotec dust filter bags
- Pyrotex KE ceramic filter elements
- Ceramic pleated elements

Our most current general sales conditions shall apply.
Please consult the most current local product data sheet prior to any use.

S E F A R